

# CABINET ASSEMBLY: EXAMPLE 7

**Hardware**

- Hinges to match Cabinet
- Handles to be White Bronze
- Legs: 4" x 1 3/4" Adjustable Stainless Steel
- Interior Shelves Available Upon Request

Thomas Outdoor Kitchens, Inc.  
630 Ramsey Ave. Hillside, N.J. 07205  
(908)-810-0030 TEL. (908)-810-1551 FAX  
Architectural Aluminum Products  
www.ThomasOutdoorKitchens.com

**Revision**

#	Date	Description
00	2020	Catalog
01	2021	Catalog
02	2022	Catalog

**Project Information**  
Quality Outdoor Kitchens  
Built to your Specifications

TOK  
STANDARD  
LAYOUTS  
Drawing Name

TOK.17  
Drawing #

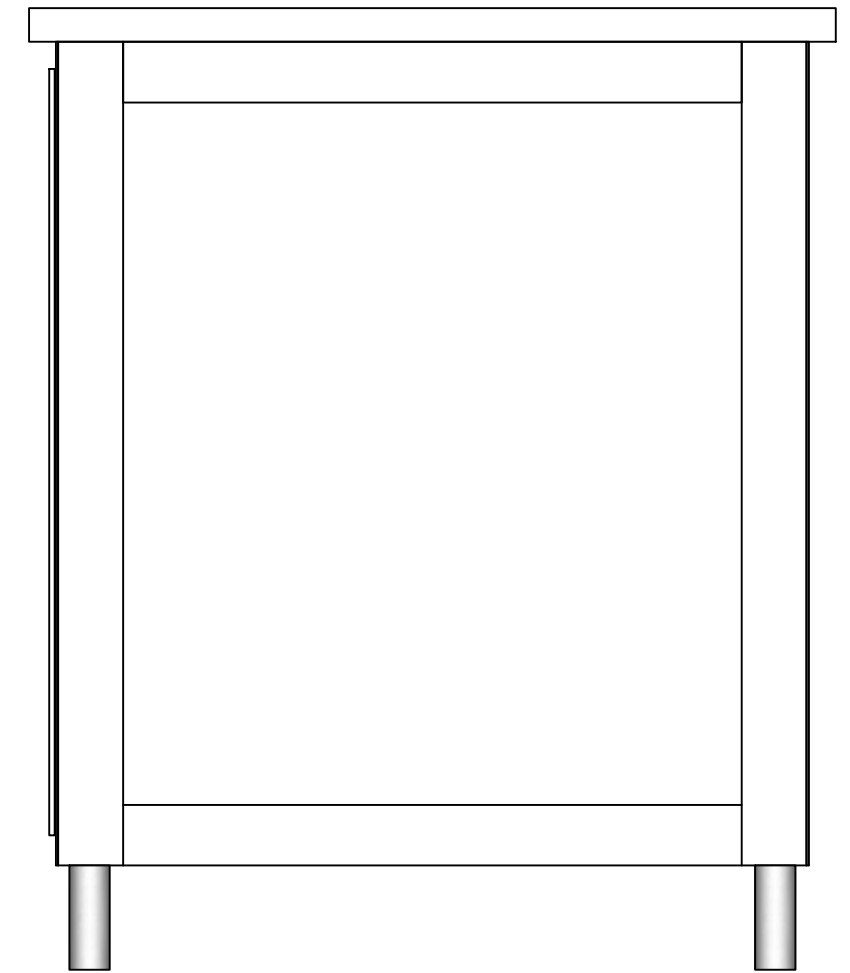
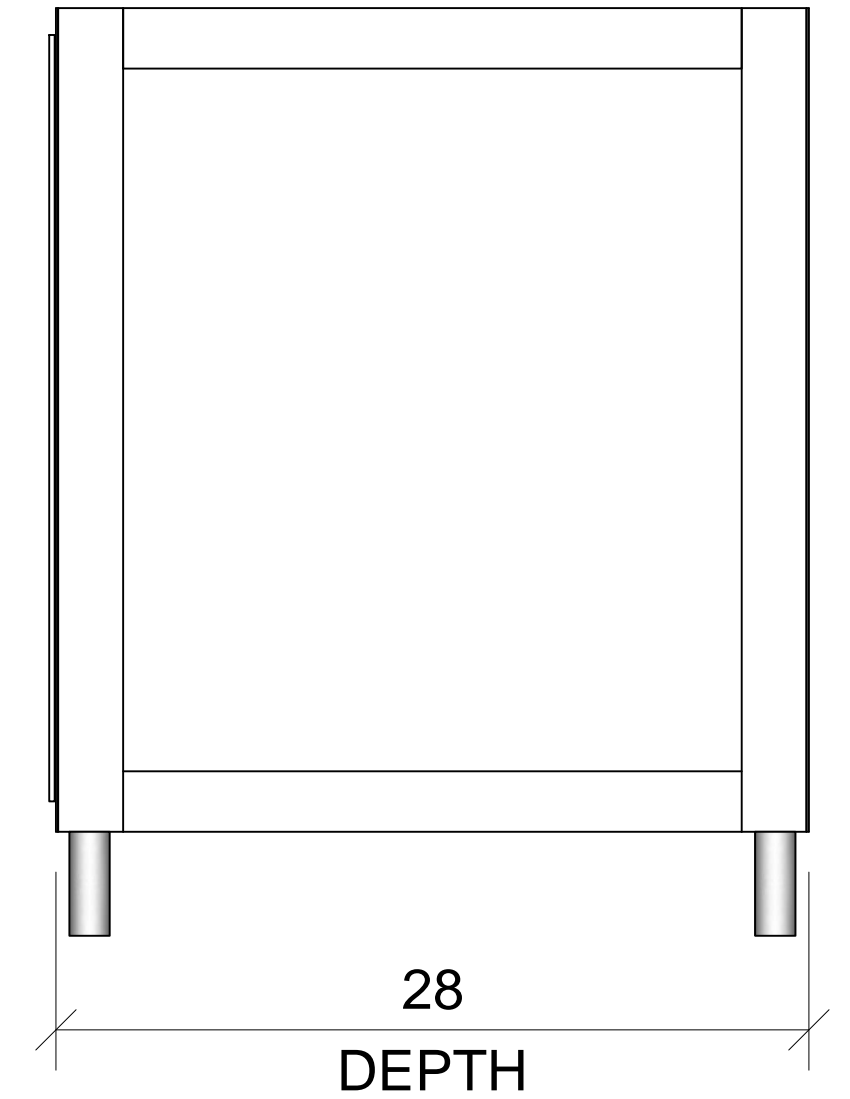
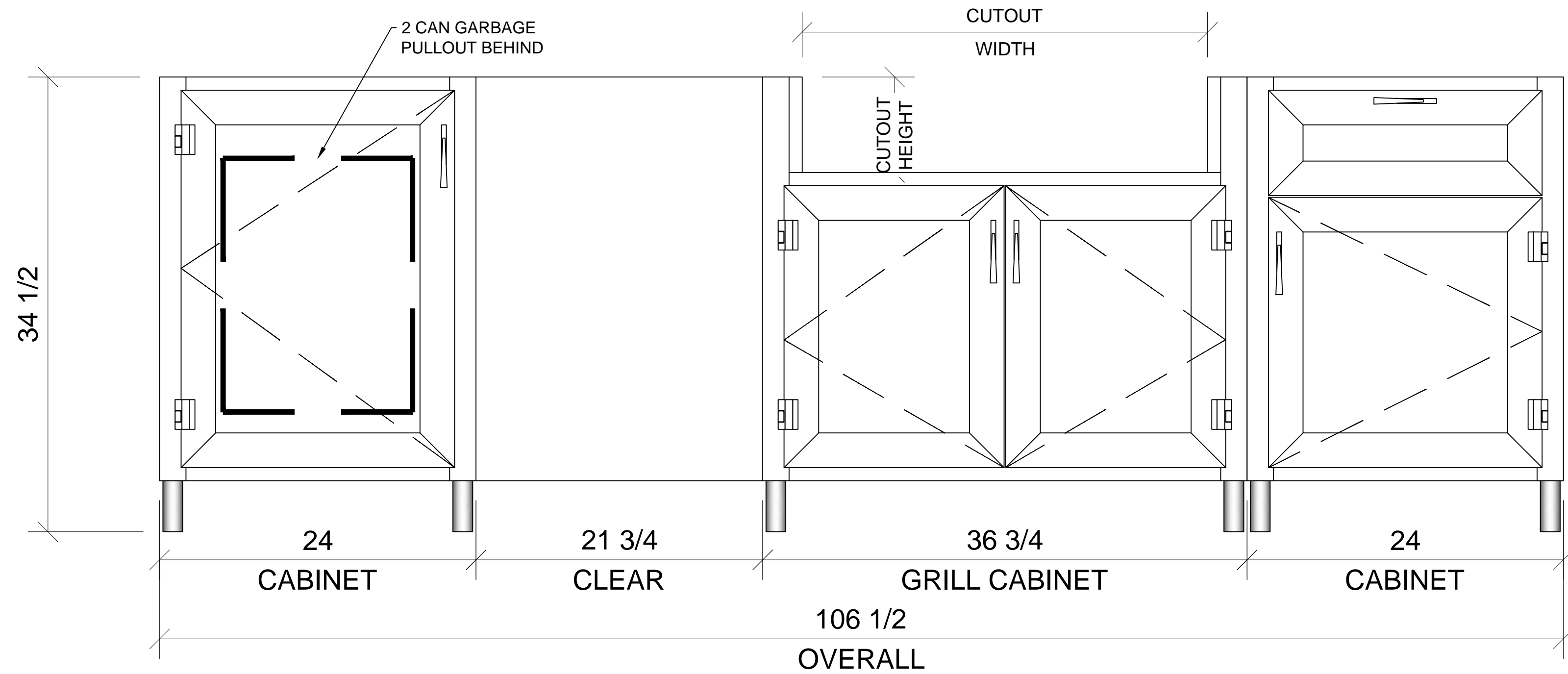
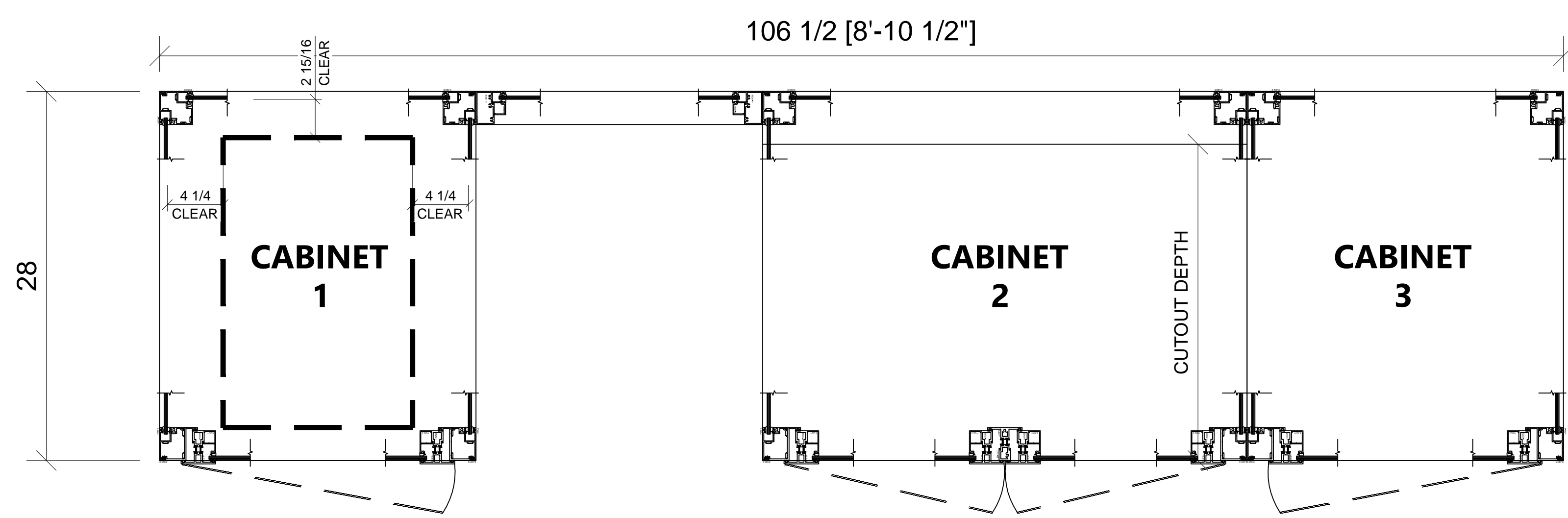

GRANITE & APPLIANCES NOT SUPPLIED BY THOMAS OUTDOOR KITCHENS

