

CABINET ASSEMBLY: EXAMPLE 14

Hardware

- Hinges to match Cabinet
- Handles to be White Bronze
- Legs: 4" x 1 3/4" Adjustable Stainless Steel
- Interior Shelves Available Upon Request

Thomas Outdoor Kitchens, Inc.
630 Ramsey Ave. Hillside, N.J. 07205
(908)-810-0030 TEL. (908)-810-1551 FAX
Architectural Aluminum Products
www.ThomasOutdoorKitchens.com

Revision

#	Date	Description
00	2020	Catalog
01	2021	Catalog
02	2022	Catalog

Project Information
Quality Outdoor Kitchens
Built to your Specifications

TOK
STANDARD
LAYOUTS
Drawing Name

TOK.24
Drawing #

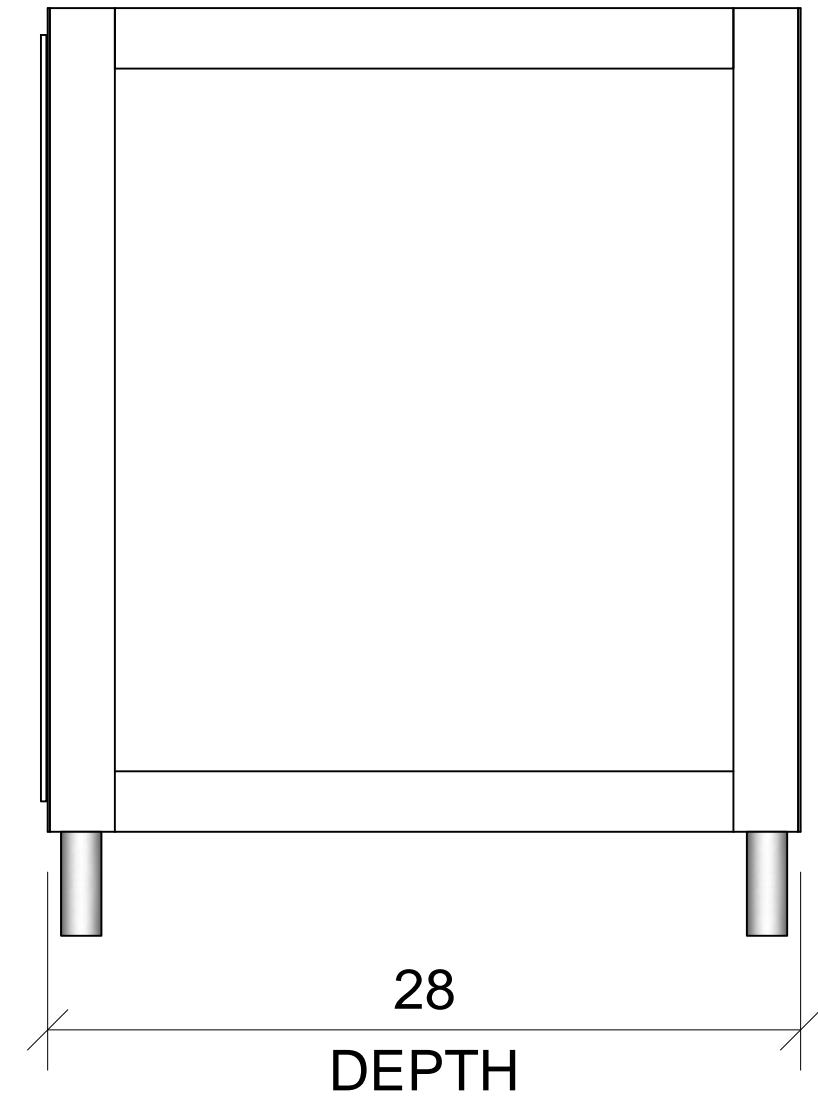
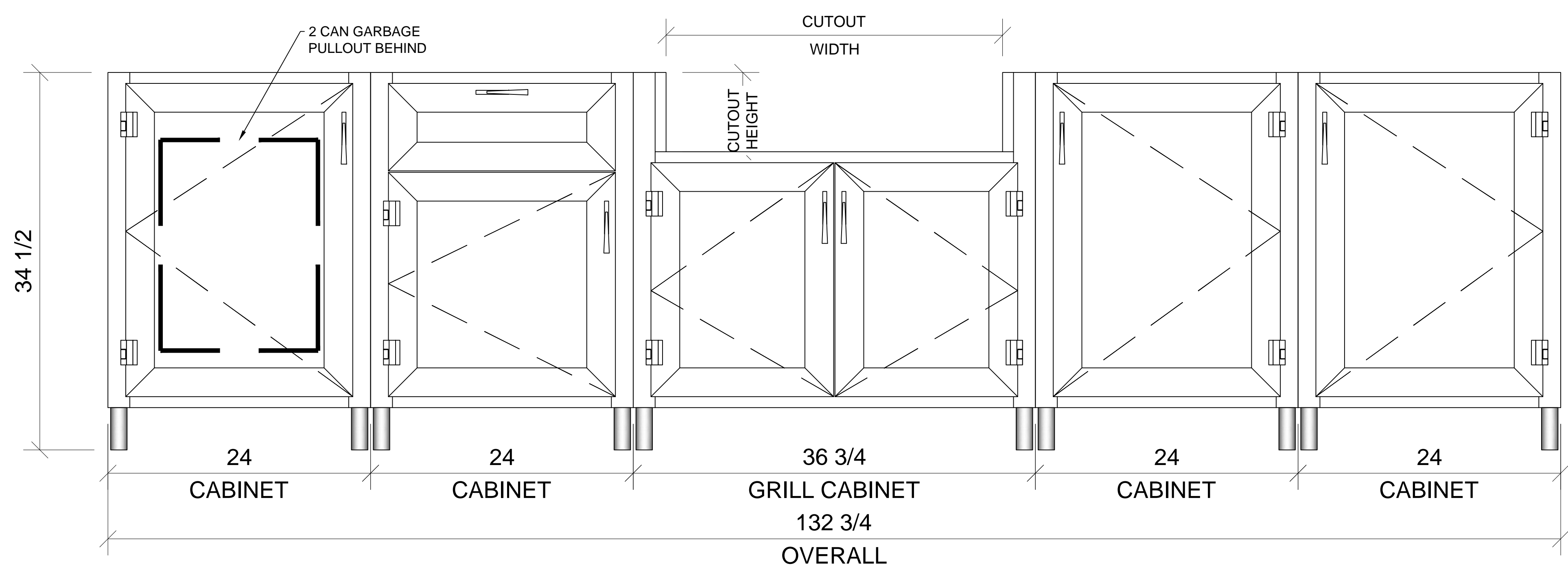
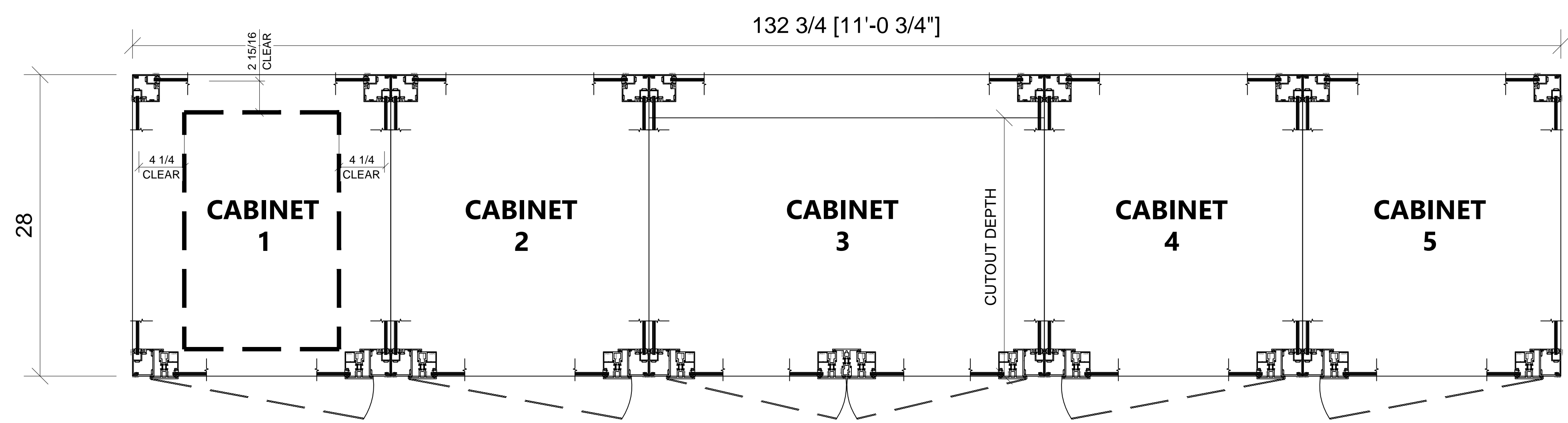

GRANITE & APPLIANCES NOT SUPPLIED BY THOMAS OUTDOOR KITCHENS

